

# PRIUS GEN IV 1.8L PERFORMANCE SIM Mcd 14

<http://VXPhysics.com/EV Performance>

## Macro Model of Hybrid Vehicle Performance: Prius

### Methodology:

First model the Prius Internal Combustion Engine's (ICE) and the motor's, torque and power. Define vehicle and road parameters.

### MG1 Starter and Controller Acceleration Protocol:

MG1 is the battery initiated starter for the ICE. "Simulate" MG1's spin startup,  $\omega_{m2}$  and  $\omega_{ice}$ , as a ramp from 0 to its maximum speed, along with the motor M2 and ICE, respectively, which are also driven by the Prius Controller to ramp up. Refer to Startup Curves on bottom of page 6. This is an arbitrary set of conditions just to start the generator turning. Note that this startup is not a function of time, but of corresponding rotations. This startup condition simulates a low gear mode for the ICE.

Evaluate two different Prius Control Strategies: Max Acceleration and Nominal. See curves on page 4.

During acceleration, the largest torque is from motor/generator MG2, which is geared to the axle. The axle determines the vehicle speed. Use the MG2 rotation,  $\omega_{m2}$ , as our control variable. During acceleration, supply peak electrical power to MG2 from both the battery (peak battery power for 10 seconds) and from MG1, which is now run as a generator at it's max speed and is mechanically driven by the ICE.

As MG2 speeds up and demands increasing power, throttle back it's peak drive/torque by limiting the MG2's electrical power input to the peak Inverter Output, i.e. the sum of the battery's and MG1 generator's peak power. Refer to the curve of M2 Torque vs.  $\omega_{m2}$  on page 3.

**Peak acceleration and 0 - 60 mph is programmed by setting the MG1 max speed:**  $\Omega_{max,m1}$

Use equations for vehicle dynamics to calculate the time to 60 mph. Plot performance simulation curves. Calculate All Electric Range, AER, miles from a single charge of the battery. Calculate AER using various EPA driving modes.

Compare Prius Performance to GM Volt.

### Basic Description of Prius

[http://en.wikipedia.org/wiki/Toyota\\_Prius](http://en.wikipedia.org/wiki/Toyota_Prius)

### Modeling and Simulation of Serial Parallel Hybrid EV

[http://www.mekatro.com/pdf/Eleco05\\_SPHEV.pdf](http://www.mekatro.com/pdf/Eleco05_SPHEV.pdf)

### Description and Design of Synergy (Planetary Gear) Drive

[http://autos.yahoo.com/green\\_center-article\\_24/](http://autos.yahoo.com/green_center-article_24/) Patent:US6005297

[www.springerlink.com/index/DL1Q76921M22P7ML.pdf](http://www.springerlink.com/index/DL1Q76921M22P7ML.pdf)

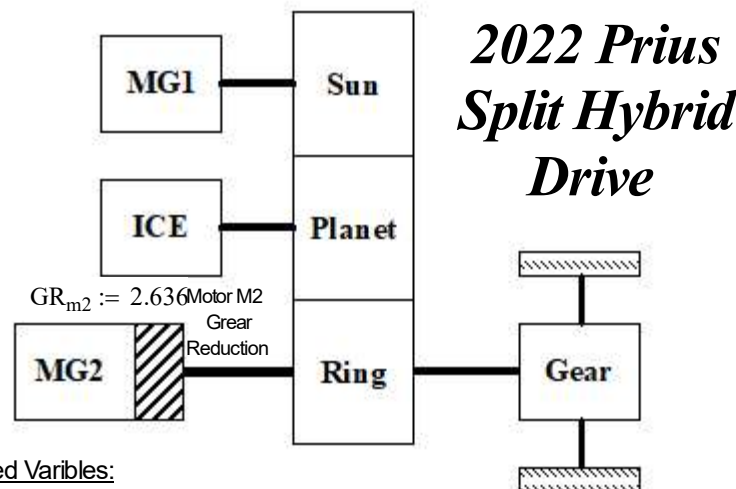

### Rotation Speed Variables:

MG1, MG2, and Engine:  $\omega_{m1}$ ,  $\omega_{m2}$ , and  $\omega_{ice}$ .

### Power Efficiencies:

Inverter, axle to tire, engine to MG1, reduction gear, and engine to axle efficiencies  $\eta_{inv}$ ,  $\eta_{axle}$ ,  $\eta_{eng\_m1}$ ,  $\eta_{red}$ , and  $\eta_{aeng\_axle}$

### Rav4 Gen III ICE Performance Curves

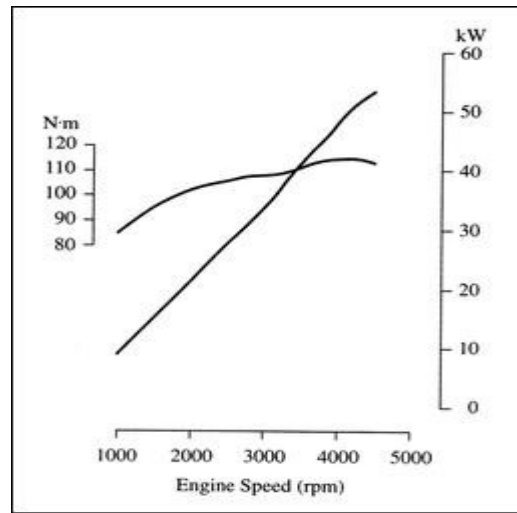

### Scale the Power and Torque Models for Toyota Atkinson Gen III 1.5L ICE to Gen IV 1.8L

#### Generation III Torque and Power Models:

$$k := 1000 \quad T_{idle} := 85 \quad \Omega_{idle} := 1000 \quad P_{idle} := T_{idle} \cdot \left( \frac{2 \cdot \pi \cdot \Omega_{idle}}{60 \cdot k} \right) \quad P_{slope} := \frac{57 - P_{idle}}{4000} \quad T_{slope} := \frac{60.23 - P_{idle}}{4000}$$

$$P_{III_{ice}}(w) := \text{if}[w < \Omega_{idle}, 0, P_{idle} + P_{slope} \cdot (w - \Omega_{idle})] \quad T_{III_{ice}}(w) := \text{if}[w < \Omega_{idle}, 0, P_{idle} + T_{slope} \cdot (w - \Omega_{idle})] \cdot \frac{60 \cdot k}{2 \cdot \pi \cdot w}$$

$$T_{III_{ice}}(w) := \text{if}(w > 5200, T_{III_{ice}}(5200), T_{III_{ice}}(w)) \quad P_{III_{ice}}(w) := \text{if}(w > 5200, P_{III_{ice}}(5200), P_{III_{ice}}(w))$$

#### Scale Up to Gen IV Specs:

$$X_p := \frac{73}{57} \cdot \frac{73}{76} \quad X_T := \frac{142}{115} \quad P_{ice}(w) := P_{III_{ice}}(w) \cdot X_p \quad T_{iceE}(w) := T_{III_{ice}}(w) \cdot X_T$$

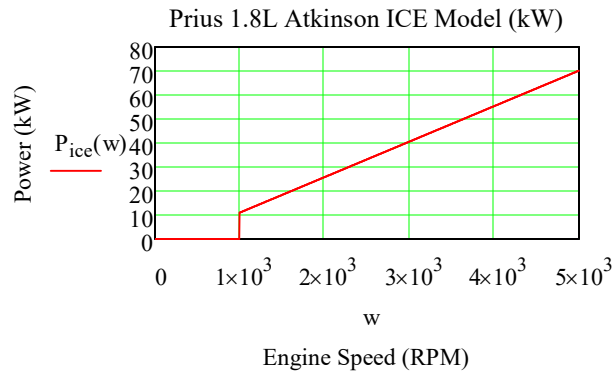
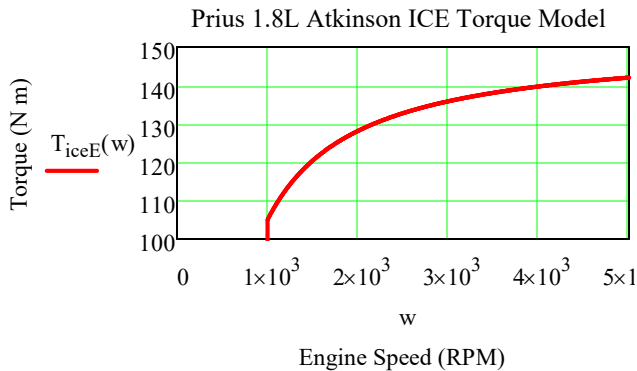

### Model Equations for the Driveshaft, ICE, and Planetary Gears

#### Simulation of a Series Hybrid Electric Vehicle based on Energetic Macroscopic Representation

W. Lhomme<sup>1</sup>, A. Bouscayrol<sup>1</sup>, Member, P. Barrade<sup>2</sup>

$$J \cdot \frac{d}{dt} \Omega_{shaft} + f \cdot \Omega_{shaft} = T_{ice} - T_{dgc}$$

$$P_{ice} = m_{ice} \cdot k_{ice} \cdot \Omega_{shaft}$$

$$T_{ice} = m_{ice} \cdot k_{ice} \cdot d_{gas}$$

$$k_{ice} = \frac{\eta \cdot \rho \cdot P_c}{\Omega_{ice\_max}}$$

$$\omega_{mg1} + 2.6 \cdot \omega_{mg2} = 3.6 \omega_{ice}$$

$J$ ,  $f$ , and  $\Omega_{shaft}$  are the moment of inertia, friction coefficient, and speed of the shaft.  $T_{ice}$  and  $T_{dgc}$  are the ICE and generator torques.

The ICE pressure,  $P_{ice}$ , results from the flow of gasoline.  $\eta$  is the ICE efficiency,  $\rho$  the density of gasoline,  $P_c$  the calorific value of gasoline and  $\Omega_{ice\_max}$  the maximum rotation speed of the engine. The control of the machine is ensured by the  $m_{ice}$  ratio, which defines the actual flow of gasoline,  $d_{gas}$ , through a specific actuator.

The relation for the shaft rotational velocities  $\omega_{ice}$ ,  $\omega_{mg1}$ , and  $\omega_{mg2}$  describes the action of the Hybrid Synergy Drive *Planetary Gear* (shown in the above illustration).

### Gen III NHW20 MG2 Motor Performance Curves

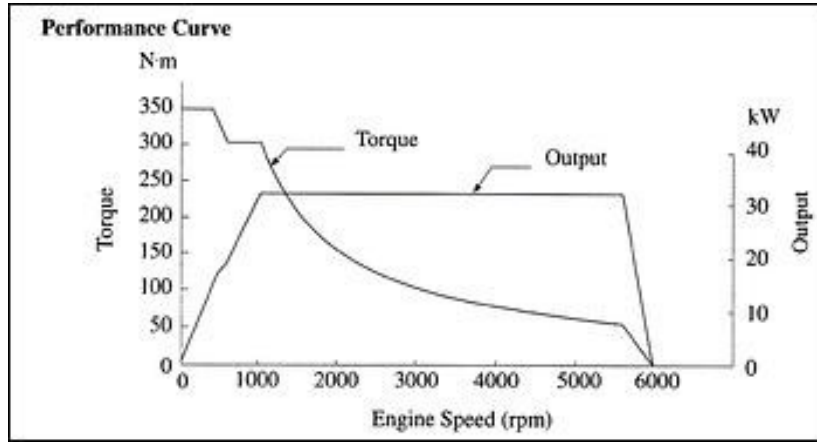

#### Toyota Prius Gen IV 1.8L-Vehicle, Motor and Road Parameters:

#### Specifications for Different Prius Models

Gear Ratio and Efficiencies:  $GR := 3.267$   $\eta_{inv} := 0.90$   $\eta_{eng\_axle} := 0.95$   $\eta_{axle} := 0.95$   $\eta_{eng\_m1} := 0.95$   $\eta_{red} := 0.95$

Max Motor Power:  $P_{max\_m2} := 60 \cdot kW \cdot \eta_{axle}$   $P_{max\_m1} := 37 \cdot kW \cdot \eta_{eng\_m1}$   $P_{max\_ice} := 73 \cdot kW \cdot \eta_{eng\_m1}$

$P_{max\_m1} = 47.137 \cdot hp$   $P_{max\_ice} = 93 \cdot hp$

Max Motor Torque:  $T_{max\_m1} := 207 \cdot ft \cdot lbf \cdot \eta_{eng\_m1}$   $T_{max\_ice} := 142 \cdot N \cdot m \cdot \eta_{eng\_m1}$

$T_{max\_m2} := 207 \cdot ft \cdot lbf \cdot GR_{m2} \cdot \eta_{axle}$

$r_{tire} := 0.287 \cdot m$

$RPM := min^{-1}$

Max Motor Speeds: **Max. Acceleration Mode ==>**  $\Omega_{max\_m1} := 9000 \cdot RPM$   $\Omega_{max\_ice} := 5200 \cdot RPM$

$\Omega_{max\_m1} := \Omega_{max\_m1}$   $T_{max\_m1} \cdot \Omega_{max\_m1} = 39.993 \cdot kW$  Note MG1's power is speed (6500 rpm) limited

#### Set Pmaxbat to 0 for Extremum

Redline :=  $\Omega_{max\_ice} \cdot min$   $T_{max\_m2} = 702.815 \cdot N \cdot m$   $Energy_{bat} := 6.5 \cdot kW \cdot hr$   $P_{max\_bat} := 27 \cdot kW$

#### Chasis and Environmental Parameters

Average Wind Velocity:	$V_w := 0 \cdot mph$	Frontal Area*:	$A_{fg} := 2.33 \cdot m^2$
Shape Correction Factor:	$SCF := 0.85$	Frontal Area Corrected:	$A_f := A_{fg} \cdot SCF$ $A_f = 1.98 \cdot m^2$
Drag Coeff:	$Cd := 0.25$	Rolling Resistance Per Tire:	$RR_{tire} := 0.007$
Cross Wind Drag Coff:	$Cd_{cw} := 0.000014$	(Average 0% road grade)	$\theta := atan(0.0)$ $\theta$ (radians):
Air Density:	$\rho := 1.293 \cdot \frac{gm}{liter}$	Average Cross Wind:	$V_{cw} := 0 \cdot mph$
Road Rolling Resist:	$RR_{road} := 0.002$	Curb Weight:	$M_{curb} := 3042 \cdot lb$
Rotational Inertia Coeff:	$k_m := 1.08$	Passenger Weight:	$Passengers2 := 170 \cdot lb$
Gross Weight:	$M_{gross} := M_{curb} + Passengers2$	$M_{gross} = 3.212 \times 10^3 \cdot lb$	$M_{batt} := 68 \cdot kg$

#### Vehicle Dynamics Equations - Find Velocity and Time for Maximum Acceleration

Road Resistance, Fr:  $Fr(v) := M_{gross} \cdot g \cdot [(RR_{tire} + RR_{road}) \cdot \cos(\theta) + \sin(\theta)]$   $Fr(60 \cdot mph) = 128.589 \cdot N$

Aerodynamic Loss, Fa:  $Fa(v) := 0.5 \cdot \rho \cdot A_f \cdot [(v + V_w)^2 \cdot Cd + Cd_{cw} \cdot (0.5 \cdot v + V_{cw})^2]$   $Fa(60 \cdot mph) = 230.295 \cdot N$

Opposing Force, Fo:  $Fo(v) := Fa(v) + Fr(v)$   $Fo(60 \cdot mph) = 358.884 \cdot N$   $Fo(60 \cdot mph) = 358.884 \cdot N$

#### Velocity vs Shaft (MG2 Rotaional Speed) and Hybrid Synergy Gearing

$$M2rpm\_at\_mph(s) := \frac{GR \cdot s}{(2 \cdot \pi \cdot r_{tire} \cdot RPM)} \quad velMG2\_at\_rpm(w) := \frac{2 \cdot \pi \cdot r_{tire} \cdot w \cdot RPM}{GR} \quad v\_r(w) := \frac{2 \cdot \pi \cdot r_{tire} \cdot w \cdot RPM}{GR \cdot mph}$$

**Control Strategies (Hybrid Synergy Drive Speed Relationships):**

**Develop an MG1 Profile and then Find Speed Relationships of MG2(ICE) and ICE(MG2)**

$\omega_{mg2}$  is not defined. Only specified as a condition or range variable.

**Max Acceleration Control Strategy P1: Turn on ICE at 15 mph (See Control Plot)**

Apply maximum MG1 power/speed  $\Omega_{max_{m1}} = 8500$  RPM from Generator MG1 to MG2.

**Hybrid Synergy Drive  
MG1 Control Strategy:**

Max MG1 Rotation  
 $\Omega_{max_{m1}}$

Initial M2 Spinup ( $\Omega_{m1}$ ),

$\Omega_{1init_{m2}}(\omega_{mg2})$

and Driving Profiles,

$\Omega_{1Prfl_{m1}}, \Omega_{1Prfl_{m2}}$

$$\Omega_{1init_{m2}}(\omega_{mg2}) := \text{if} \left( \omega_{mg2} < 700 \wedge P_{max_{bat}} > 1 \cdot \text{kW}, 1000 + \frac{\Omega_{max_{m1}}}{820} \cdot \frac{\omega_{mg2}}{\text{RPM}}, \Omega_{max_{m1}} \cdot \text{min} \right)$$

$$\Omega_{1init_{ice}}(\omega_{ice}) := \text{if} \left( \omega_{ice} < 1700 \wedge P_{max_{bat}} > 1 \cdot \text{kW}, 1000 + \frac{\Omega_{max_{m1}}}{1950} \cdot \frac{\omega_{ice}}{\text{RPM}}, \Omega_{max_{m1}} \cdot \text{min} \right)$$

$$\Omega_{1Prfl_{m1}}(\omega_{mg2}) := \Omega_{1init_{m2}}(\omega_{mg2})$$

**Nominal Control Strategy P2: Constant ICE (rpm= 1800) to 60 mph, then ramp up. Profile 2-  $\Omega_{1Prfl_{m2}}$**

Use just  $\Omega_{ice\_vel}(\text{vel})$  to find resultant relation between MG1 and Velocity, i.e. MG2

$$\text{Vel}_{rev\_up} := 60 \quad \Omega_{ice\_vel}(\text{vel}) := \text{if} \left[ \text{vel} < \text{Vel}_{rev\_up}, 1800, 1800 + (\text{vel} - \text{Vel}_{rev\_up}) \cdot \frac{4000 - 1800}{100 - \text{Vel}_{rev\_up}} \right]$$

**Calculate Control Point:**

Rev up ICE from Cruise at

Vehicle Velocity  $\text{Vel}_{rev\_up}$

See Plot Lower Right

$$\Omega_{iceVel}(\omega_{mg2}) := \Omega_{ice\_vel} \left( \frac{\text{velMG2\_at\_rpm}(\omega_{mg2})}{\text{mph}} \right) \quad \Omega_{iceVel}(5000) = 4.159 \times 10^3$$

$$\Omega_{1Prfl_{m1}}(\omega_{mg2}) := 3.6 \cdot \Omega_{iceVel}(\omega_{mg2}) - 2.6 \omega_{mg2}$$

Examination of above then gives us the form of  $\Omega_{1Prfl_{vm1}}(v)$

$$\Omega_{1Prfl_{vm1}}(v) := \text{if} \left[ v < 60, 6500 - \frac{7500}{60} \cdot v, -1000 + (v - 60) \cdot \frac{4000}{60} \right] \quad x_{m2} := 1500$$

**ICE and MG2 Rotation Profiles From MG1 Profiles  $\Omega_{1Prfl_{m1}}$  (Enabled) or  $\Omega_{1Prfl_{m2}}$  (Disabled<sup>■</sup>):**

$$\Omega_{ice}(\omega_{mg2}) := \frac{(\Omega_{1Prfl_{m1}}(\omega_{mg2}) + 2.6 \cdot \omega_{mg2})}{3.6} \quad \Omega_{mg2}(\omega_{ice}) := \text{root} \left( x_{m2} - \frac{\omega_{ice} \cdot 3.6 - \Omega_{1Prfl_{m1}}(x_{m2})}{2.6}, x_{m2} \right)$$

$$\Omega_{ice}(\omega_{mg2}) := \frac{(\Omega_{1Prfl_{vm1}}(v_r(\omega_{mg2})) + 2.6 \cdot \omega_{mg2})}{3.6} \quad \Omega_{mg2}(\omega_{ice}) := \text{root} \left( x_{m2} - \frac{\omega_{ice} \cdot 3.6 - \Omega_{1Prfl_{vm1}}(v_r(x_{m2}))}{2.6}, x_{m2} \right)$$

Use these expressions Just for generating plots at bottom of page

$$\Omega_{iceP1}(\omega_{mg2}) := \frac{(\Omega_{1Prfl_{m1}}(\omega_{mg2}) + 2.6 \cdot \omega_{mg2})}{3.6} \quad \Omega_{iceP2}(\omega_{mg2}) := \frac{(\Omega_{1Prfl_{vm1}}(v_r(\omega_{mg2})) + 2.6 \cdot \omega_{mg2})}{3.6}$$

$$\Omega_{ice}(M2rpm\_at\_mph(120 \cdot \text{mph})) = 6.712 \times 10^3$$

**Control Strategy Plots: Max Acceleration and Nominal Cruise Profiles**

**Plot Colors: MG2 Shaft Rotational Speed (Red), ICE RPM (Blue), and MG1 Rotor (Green).**

**Note Max Accel Plot:** ICE does not turn on until MG2 propels Vehicle Speed up to 15 mph

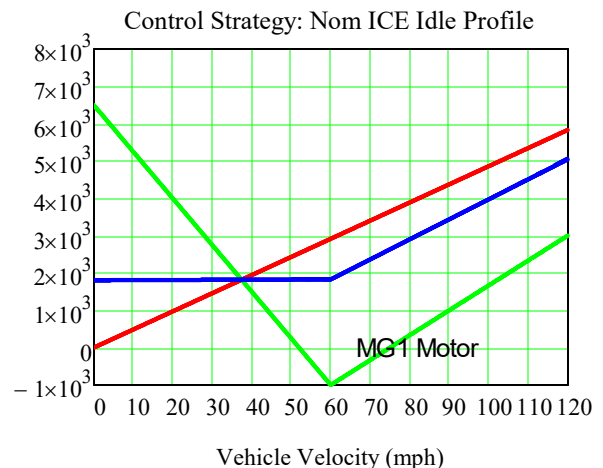
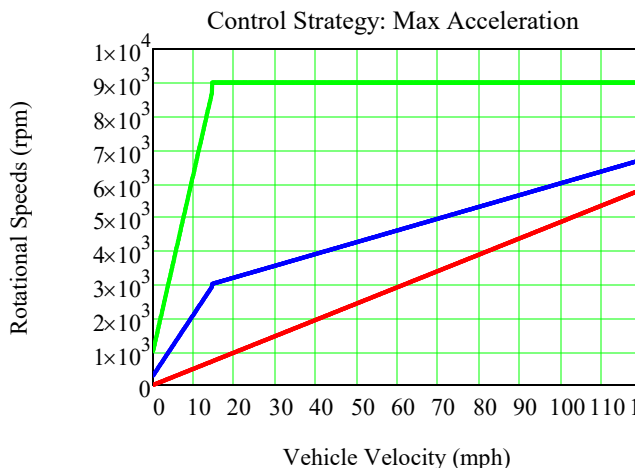

**Given Control Acceleration Strategy Ω1Prfl1m1: Calculate Power and Torque**

Torque, ICE:  $T_{icem2}(\omega_{mg2}) := T_{iceE}(\Omega_{ice}(\omega_{mg2})) \cdot N \cdot m$   $\Omega 1Prfl_{m1}(7000) = 9 \times 10^3$

Torque, MG1:  $T_{m1}(\omega_{mg2}) := -T_{icem2}(\omega_{mg2}) \cdot 3.6^{-1} \cdot \eta_{eng\_m1}$

$P_{invA_{m2}}(\omega_{mg2}) := \eta_{inv} \cdot (P_{max_{bat}} - T_{m1}(\omega_{mg2}) \cdot 2 \cdot \pi \cdot \Omega_{max_{m1}})$

$P_{invB_{m2}}(\omega_{mg2}) := \text{if}(P_{invA_{m2}}(\omega_{mg2}) \geq P_{max_{m2}} \cdot \eta_{inv}, P_{max_{m2}} \cdot \eta_{inv}, P_{invA_{m2}}(\omega_{mg2}))$

**Max Power to Inverter: < P2max, P1max + Pbatmax and Pm1 < P1max and Pice x 2.6/3.6**

MG2 Inverter Power, Pinv:

$P_{inv_{m2}}(\omega_{mg2}) := \text{if}[-(T_{m1}(\Omega 1init_{m2}(\omega_{mg2})) \cdot 2 \cdot \pi \cdot \Omega_{max_{m1}}) > P_{max_{m1}}, (P_{max_{bat}} + P_{max_{m1}}) \cdot \eta_{inv}, P_{invB_{m2}}(\omega_{mg2})]$

Torque MG2  
Power Limited  
Break Point,  $\omega_{inv}$

Problem. Find  $\omega_{inv}$  such that:  
 $(T_{max_{m2}}) \omega_{inv} = P_{inv_{m2}}(\omega_{inv})$

Guess for  $\omega_{inv}$ , wx:

$wx := \text{if}(P_{max_{bat}} < 1 \cdot kW, 8, 800)$

$\omega_{inv} := \text{root}\left[T_{max_{m2}} - \frac{P_{inv_{m2}}(wx)}{(2 \cdot \pi \cdot wx + 1) \cdot \text{RPM}}, wx\right]$  **Solution (rpm):**  
 $\omega_{inv} = 759.842$

Torque, MG2:  $T_{m2}(\omega_{mg2}) := \text{if}\left(\omega_{mg2} \leq \omega_{inv}, T_{max_{m2}}, \frac{P_{inv_{m2}}(\omega_{mg2})}{2 \cdot \pi \cdot \omega_{mg2} \cdot \text{RPM}}\right)$   $T_{m2}(\omega_{inv}) \cdot 2 \cdot \pi \cdot \omega_{inv} \cdot \text{RPM} = 55.923 \cdot kW$

Tractive Torq, Total:  $T_{tot}(\omega_{mg2}) := T_{m2}(\omega_{mg2}) + T_{icem2}(\omega_{mg2}) \cdot \frac{2.6}{3.6} \cdot \eta_{eng\_axle}$   $P_{m2}(\omega) := T_{m2}(\omega) \cdot 2 \cdot \pi \cdot \omega \cdot \text{RPM}$

Tractive Road Force, Total:  $F_t \omega(\omega_{mg2}) := \frac{T_{tot}(\omega_{mg2}) \cdot GR \cdot \eta_{red}}{r_{tire}}$

Tractive Road Force, Total:  $F_{tot}(v) := \frac{T_{tot}(M2rpm\_at\_mph(v)) \cdot GR \cdot \eta_{red}}{r_{tire}}$   $P_{M2}(\omega) := \frac{P_{m2}(\Omega_{mg2}(\omega))}{kW}$

Plot Terms:  $P_{tot}(v) := F_{tot}(v) \cdot v$   $P_{tot}(60 \cdot \text{mph}) = 108.955 \cdot \text{hp}$

**Applying maximum motor torque, find the velocity and time starting from initial velocity = 0 mph.**

Third Law of Motion:  
(dv/dt is acceleration)

Given

$a(v) := \frac{F_{tot}(v) - F_o(v)}{k_m \cdot M_{gross}}$

End := 40

$\underline{V} := 0 \cdot \text{mph}$   $\text{vel}(t) := \text{root}\left(t \cdot \text{sec} - \int_0^V \frac{\text{mph}}{a(V \cdot \text{mph})} dV, V\right) \cdot \text{mph}$   $\underline{\text{time}}(v) := \int_0^v \frac{1}{a(v)} dv$  **time(60mph) = 9.171 s**  
**vel(1.9) = 21.343 mph**

velocity(t) := vel(t)

$a(85\text{mph}) = 0.121 \cdot g$   $v_{gfall} := 85$   $\text{time}(60\text{mph}) = 9.171 \text{ s}$

$\text{accel}(t) := \frac{F_{tot}(\text{velocity}(t)) - F_o(\text{velocity}(t))}{k_m \cdot M_{gross}}$   $P_t(\omega_{m2}) := T_{tot}(\omega_{m2}) \cdot 2 \cdot \pi \cdot \omega_{m2} \cdot \text{RPM} \cdot kW^{-1}$

Time := 0 sec  $\underline{\text{time}}(v) := \text{root}(v - \text{velocity}(\text{Time}), \text{Time})$

**Passing 40 to 60 mph:**  $\text{Passing} := \text{time}(60 \cdot \text{mph}) - \text{time}(40 \cdot \text{mph})$

# PRIUS GEN IV PERFORMANCE SIMULATION CURVES

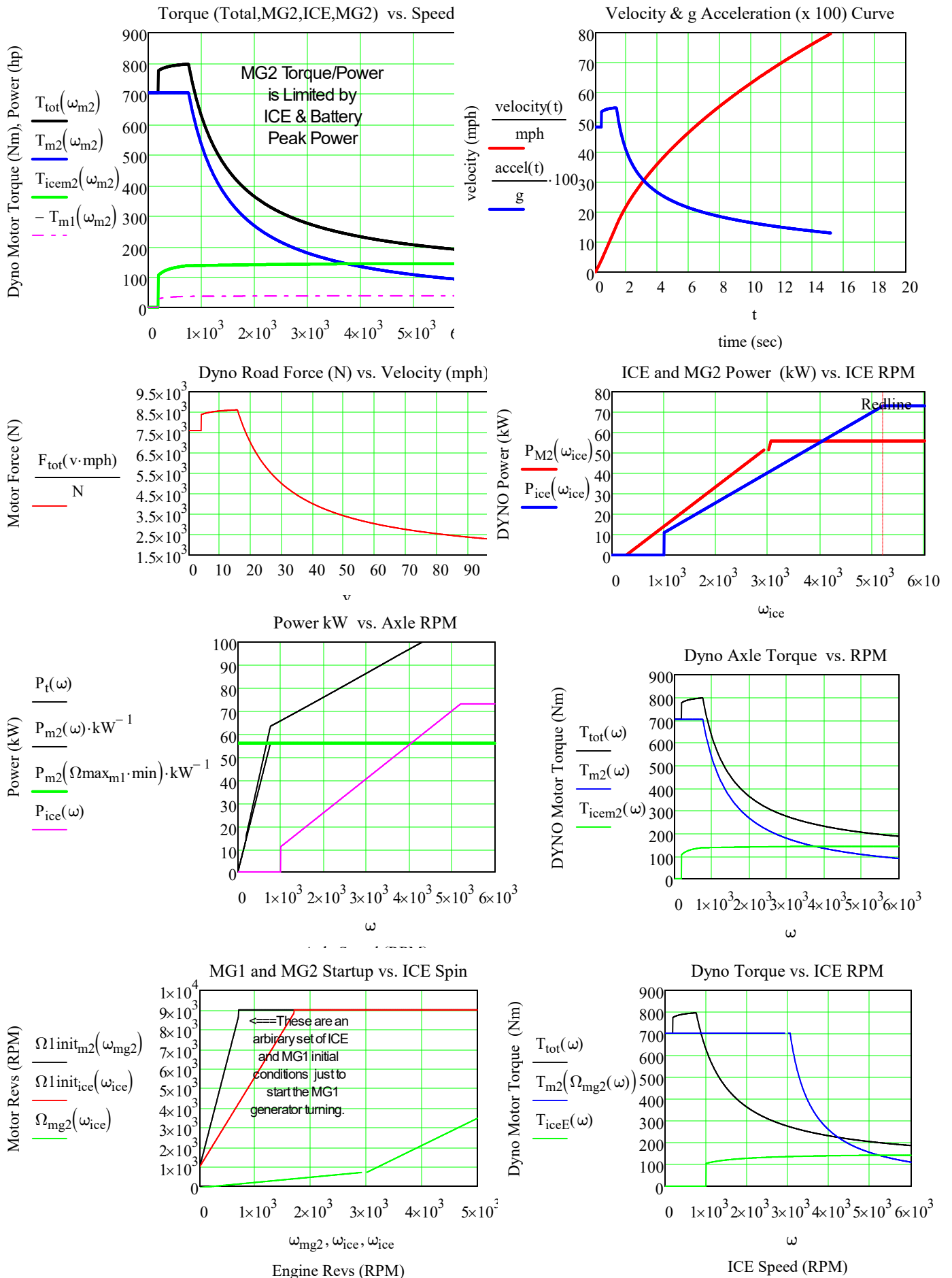

## Find the Single Charge (@SOC = 50%) Cruise Range for a given Velocity

### Driving Pattern/Profile:

Given we **cruise at constant speed** and Time for start, stop, and regen braking,  $\text{Time}_{\text{ssr}}$  = every 15 minutes.

### Drive Train Power Efficiency - Battery Loss to Force Commanded Vehicle Velocity:

State of Charge for generator is  $\text{SOC}_{\text{gen}}$  **SOC(v) is 50% for recharge**. 201V HV battery **idle power is  $P_o$** . 12V battery gives Accessory Power. The Traction Inverter x motor Efficiency -  $\text{TInvE}$ , HV Power Electronics at Idle Efficiency -  $\text{IPEE}$ , and Gear Power Efficiency -  $\text{GPE}$  are 90%, 95%, and 97%, respectively. Brake Regen efficiency of kinetic energy is 69% @ deceleration = 0.315g. Then the number of starts per hour as a function of velocity,  $\text{NS}$ ,  $\text{NumStarts}(v, P_o)$ , is

$$\text{Time}_{\text{ssr}} := 30\text{min} \quad \text{TInvE} := 0.90 \quad \text{IPEE} := 0.95 \quad \text{GPE} := 0.97 \quad \text{Regen} := 0.69 \quad \text{SOC}_{\text{gen}} := 0.5$$

$$\text{Power}_{\text{dissLoss}}(v, P_o) := \frac{F_o(v) \cdot v}{\text{TInvE} \cdot \text{GPE}} + \frac{P_o \cdot \text{watt}}{\text{IPEE}}$$

### USABC Round Trip Battery Energy Efficiency

$$\text{RTEff} := 0.92$$

$$\text{Energy}_{\text{accel}}(v) := \text{Pmax}_{m2} \cdot \text{time}(v)$$

NS, NS are iterative converging estimates of total NumStarts per charge

$$\text{NS}_o(v) := 2 \cdot \left[ \frac{65\text{mph}}{(v + 0.1 \cdot \text{mph})} \right]^2 \quad \text{NS}(v, P_o, \text{SOC}_f) := \frac{\text{Energy}_{\text{bat}}(1 - \text{SOC}_f) - \text{NS}_o(v) \cdot \left[ \frac{M_{\text{gross}}(v)^2}{2} (1 - \text{Regen}) \right]}{\text{Power}_{\text{dissLoss}}(v, P_o) \cdot 15 \cdot \text{min}}$$

$$\text{NumStarts}(v, P_o, \text{SOC}_f) := \text{floor} \left[ \frac{\text{Energy}_{\text{bat}}(1 - \text{SOC}_f) - \text{NS}(v, P_o, \text{SOC}_f) \cdot \left[ \frac{M_{\text{gross}}(v)^2}{\text{TInvE} \cdot \text{GPE}} (1 - \text{Regen}) \right]}{\text{Power}_{\text{dissLoss}}(v, P_o) \cdot 15 \cdot \text{min}} \right]$$

$$\text{Cruise\_Range}(v, P_o, \text{SOC}_f) := \frac{\text{Energy}_{\text{bat}}(1 - \text{SOC}_f) - \text{NumStarts}(v, P_o, \text{SOC}_f) \cdot \left[ \frac{\text{Regen} \cdot M_{\text{gross}}(v)^2}{\text{TInvE} \cdot \text{GPE}} (1 - \text{Regen}) \right]}{\text{Power}_{\text{dissLoss}}(v, P_o)} \cdot v$$

### Highway Cruise Range with Four Stops per Hour Estimate

$$\text{Cruise\_Range}(30 \cdot \text{mph}, 50, \text{SOC}_{\text{gen}}) = 32.742 \cdot \text{mi}$$

$$\text{Cruise\_Range}(40 \cdot \text{mph}, 50, \text{SOC}_{\text{gen}}) = 26.649 \cdot \text{mi}$$

$$\text{Cruise\_Range}(50 \cdot \text{mph}, 100, \text{SOC}_{\text{gen}}) = 21.358 \cdot \text{mi}$$

$$\text{Cruise\_Range}(60 \cdot \text{mph}, 100, \text{SOC}_{\text{gen}}) = 17.133 \cdot \text{mi}$$

$$\text{Cruise\_Range}(70 \cdot \text{mph}, 100, \text{SOC}_{\text{gen}}) = 14.263 \cdot \text{mi}$$

$$\text{Cruise\_Range}(60 \cdot \text{mph}, 200, \text{SOC}_{\text{gen}}) = 16.972 \cdot \text{mi}$$

$$v := 0, 2.. 80$$

$$\text{Cruise\_Range}(70 \cdot \text{mph}, 50, 0.5) = 14.31 \cdot \text{mi}$$

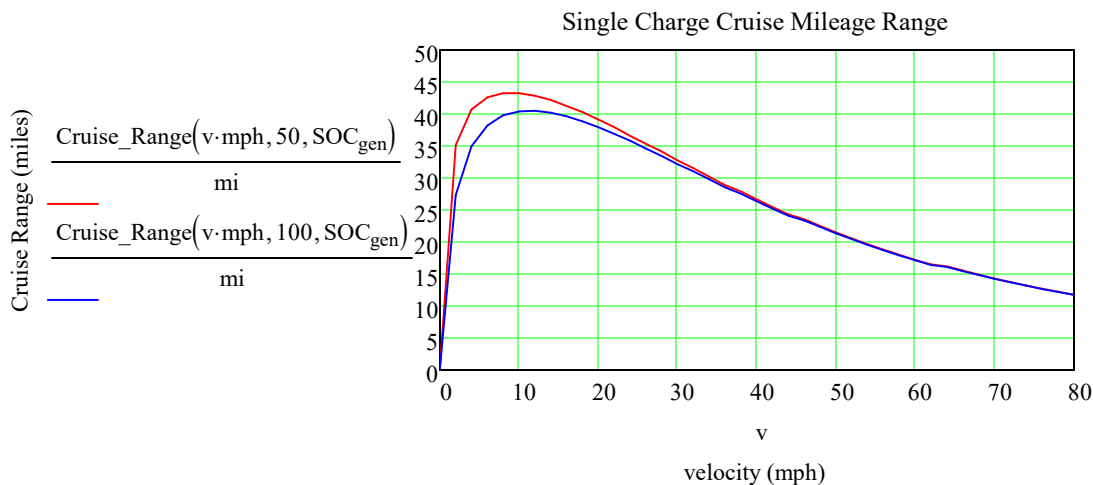

**Cruise Range as a Function of Traction Battery Idle Power, Po**

$\text{Cruise\_Range}(15\text{-mph}, 50, 0.3) = 58.43\text{-mi}$

$\text{Cruise\_Range}(55\text{-mph}, 50, 0.5) = 19.229\text{-mi}$

$180 \cdot \frac{\text{km}}{\text{hr}} = 111.847 \cdot \frac{\text{mi}}{\text{hr}}$

$\frac{0.5 - 0.25}{0.5} = 0.5$

$\frac{\text{Cruise\_Range}(55\text{-mph}, 100, 0.25) - \text{Cruise\_Range}(55\text{-mph}, 100, 0.5)}{\text{Cruise\_Range}(55\text{-mph}, 100, 0.5)} = 0.491$

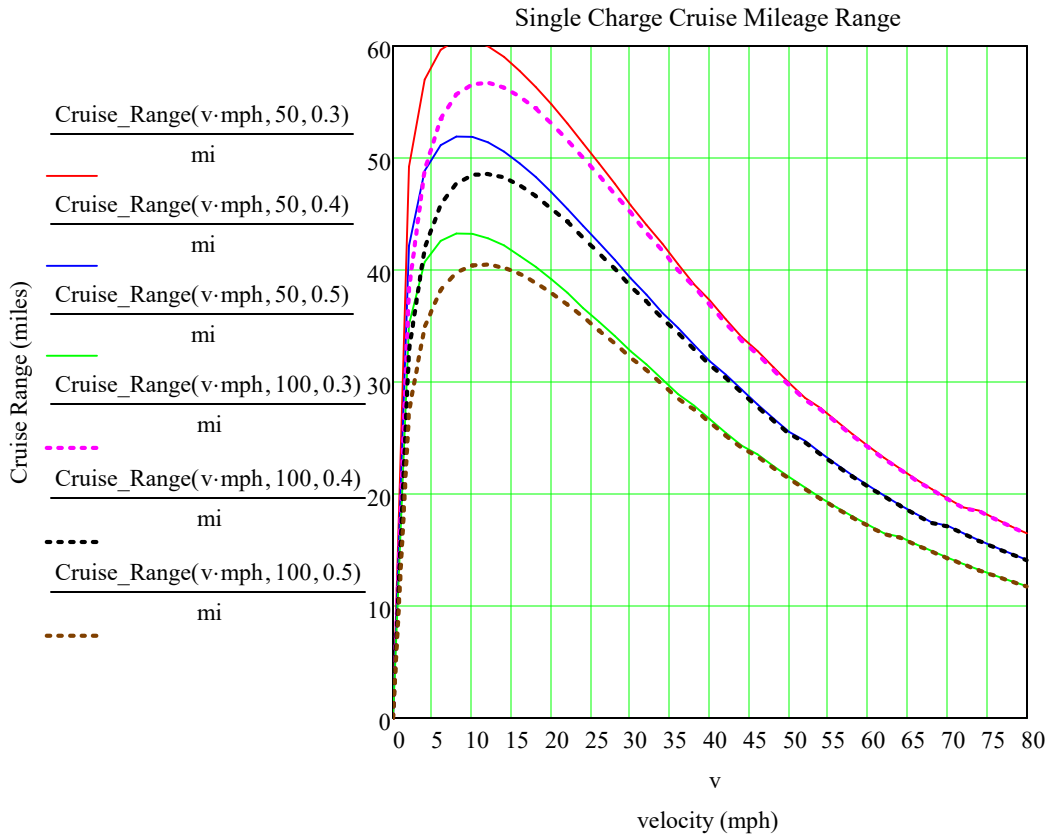



## Find the Power to Maintain Constant Velocity

Note: The generator's output is 54 kW. This allows it produce a net charge up to 80 mph cruise.

$$\text{Power}_{\text{cruise}}(v, P_o) := \text{Power}_{\text{dissLoss}}(v, P_o)$$

$$\text{Power}_{\text{cruise}}(60 \cdot \text{mph}, 100) = 11.132 \cdot \text{kW}$$

$$n := 0..200 \quad \tau_n := \frac{n}{10} \quad w_n := \frac{n}{20} \quad vv_n := \frac{n}{2}$$

$$P_{\text{cruise}_n} := \frac{\text{Power}_{\text{cruise}}(vv_n \cdot \text{mph}, 100)}{\text{k-watt}}$$

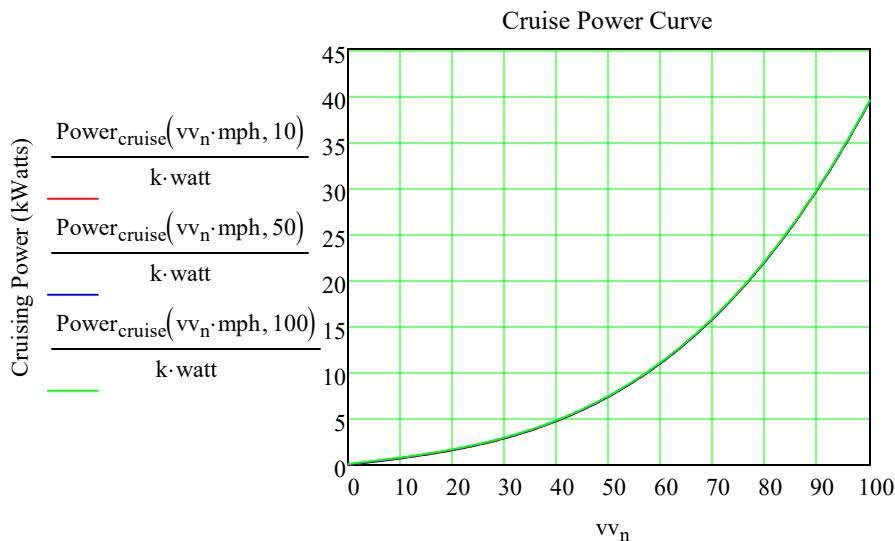

```

https://www.vxphysics.com/Transportation/
velocity (mph)
FTPF := READPRN("C:\Users\tom\Documents\_Mathcad\Electric_Vehicles\FedTestProc.TXT")
UDDSF := READPRN("C:\Users\tom\Documents\_Mathcad\Electric_Vehicles/uddscol.txt")
HWYF := READPRN("C:\Users\tom\Documents\_Mathcad\Electric_Vehicles/hwycol.txt")
FP10 := READPRN("C:\Users\tom\Documents\_Mathcad\Electric_Vehicles/FTP10Hz.TXT")
HY10 := READPRN("C:\Users\tom\Documents\_Mathcad\Electric_Vehicles/HWY10Hz.txt")
US06F := READPRN("C:\Users\tom\Documents\_Mathcad\Electric_Vehicles/US06PROFILE.TXT")

```

## AER Given Three Different Driving Schedules

### Read US06 and FTP Driving Profile Files

<http://www.epa.gov/nvfel/testing/dynamometer.htm>

The US06 cycle represents an 8.01 mile (12.8 km) route with an average speed of 48.4 miles/h (77.9 km/h), maximum speed 80.3 miles/h (129.2 km/h), and a duration of 596 seconds.

The Federal Test Procedure(FTP) is composed of the UDDS followed by the first 505 seconds of the UDDS. It is often called the EPA75. FP10 is a 10 Hz Sampling. HY10 is the 10 Hz Highway schedule.

$$\begin{aligned} tx := \text{FTP}^{(0)} \quad \text{FTP} := \text{FTP}^{(1)} \quad \text{rows}(\text{FTP}) &= 1.875 \times 10^3 \\ \text{UDDS} := \text{UDDSF}^{(1)} \quad \text{rows}(\text{UDDS}) &= 1.37 \times 10^3 \\ \text{HWY} := \text{HWYF}^{(1)} \quad R_{\text{hwy}} := \text{rows}(\text{HWY}) & \end{aligned}$$

$$\text{FTP10V} := \text{submatrix}(\text{FP10}, 0, \text{rows}(\text{FP10}) - 1, 1, \text{cols}(\text{FP10}) - 1)$$

$$\text{HWY10V} := \text{submatrix}(\text{HY10}, 0, \text{rows}(\text{HY10}) - 1, 1, \text{cols}(\text{HY10}) - 1)$$

$$\text{time} := \text{US06F}^{(0)} \quad \text{US06} := \text{US06F}^{(1)} \quad n_6 := 0..598$$

**All Electric Range, AER, for Driving Profile Velocity/Time File, P Sampling Rate, Hz, and SOC = 0**

**Regen Efficiency Curve vs Decel (g):**  $REff(g) := \frac{85}{77} \cdot 0.01 \cdot \left[ \left( 1 - e^{-27.129 \cdot g} \right) \cdot 91.235 - 28.408 \right]$   $Gg := \frac{\text{mph}}{\text{sec} \cdot g}$

```

AER(P, Hz) :=
  Ebat ← E_diss ← v_old ← 0
  n ← -1
  N ← rows(P) - 1
  while E_diss <  $\frac{\text{Energy}_{\text{bat}}}{\text{kW} \cdot \text{hr}}$ 
    n ← n + 1
    t ← mod(n, N)
    v ← P_t
    v_avg ← (v + v_old) · 0.5
    P_accel ←  $\frac{k_m \cdot M_{\text{gross}} \cdot (v - v_{\text{old}}) \cdot \frac{\text{mph} \cdot \text{Hz}}{\text{sec}} \cdot v_{\text{avg}} \text{mph}}{\text{TInvE} \cdot \text{GPE}}$  if v > v_old
    P_accel ←  $k_m \cdot M_{\text{gross}} \cdot (v - v_{\text{old}}) \cdot \frac{\text{mph} \cdot \text{Hz}}{\text{sec}} \cdot v_{\text{avg}} \text{mph} \cdot REff\left[\frac{(v_{\text{old}} - v) \cdot \text{Hz} \cdot Gg}{1}\right]$  otherwise
    E_diss ← E_diss +  $\frac{(\text{Power}_{\text{dissLoss}}(v \cdot \text{mph}, 100) + P_{\text{accel}}) \cdot \text{sec}}{\text{kW} \cdot \text{hr} \cdot \text{Hz}}$ 
    v_old ← v
    Ebat_n ← E_diss
  R ←  $\sum_{m=0}^n \frac{(P_{\text{mod}(m, N)} + P_{\text{mod}(m+1, N)}) \cdot \text{mph} \cdot \text{sec}}{2 \cdot \text{mi} \cdot \text{Hz}}$ 
  R
  
```

$r1 := 0..rows(\text{HY}10) \cdot 10 - 1$        $\text{HWY}10_{r1} := \text{HWY}10V_{\text{ceil}\left(\frac{r1+1}{10}\right)-1, \text{mod}(r1, 10)}$

$\text{AER}(\text{US}06, 1) = 22.039$        $\text{AER}(\text{FTP}, 1) = 33.524$        $\text{AER}(\text{HWY}, 1) = 33.053$        $\text{AER}(\text{HWY}10, 10) = \blacksquare$

**EPA 20085 Cycle MPG Fuel Economy Least Squares Fit Regression for AER to SOC = 0**

$\text{MPG}_{\text{city}} := \frac{1}{\left( 0.003259 + \frac{1.18053}{\text{AER}(\text{FTP}, 1)} \right)}$   $\text{MPG}_{\text{city}} = 25.992$        $\text{MPG}_{\text{hwy}} := \frac{1}{0.001376 + \frac{1.3466}{\text{AER}(\text{HWY}, 1)}}$        $X := \frac{1}{40}$

$\text{MPG}_{\text{epa}} := 0.55 \cdot \text{MPG}_{\text{city}} + 0.45 \cdot \text{MPG}_{\text{hwy}}$        $\text{MPG}_{\text{epa}} = 24.98$

$r := 0..rows(\text{FTP}) - 1$        $\text{Distance}_r := \sum_{r=0}^r \text{FTP}_r \cdot \frac{10}{60 \cdot 60}$        $rr := 0..rows(\text{US}06) - 1$        $\text{Distance}_{rr} := \sum_{rr=0}^{rr} \text{US}06_{rr} \cdot \frac{10}{60 \cdot 60}$   
 $\text{max}(\text{Distance}) = 110.414$        $\text{max}(\text{Distance}_{rr}) = 80.08$

**SAVE PROFILES**

WRITEPRN("EFTP.PRN") := AER(FTP,1)·40      E<sub>FTP</sub> := READPRN("EFTP.PRN")      max(E<sub>FTP</sub>)·X = 33.525  
 WRITEPRN("EUS06.PRN") := AER(US06,1)·40      E<sub>US06</sub> := READPRN("EUS06.PRN")      max(E<sub>US06</sub>)·X = 22.04  
 WRITEPRN("EHWY.PRN") := AER(HWY,1)·40      E<sub>HWY</sub> := READPRN("EHWY.PRN")      max(E<sub>HWY</sub>)·X = 33.05

US06 Drive Cycle: Distance, E(Bat Drain)

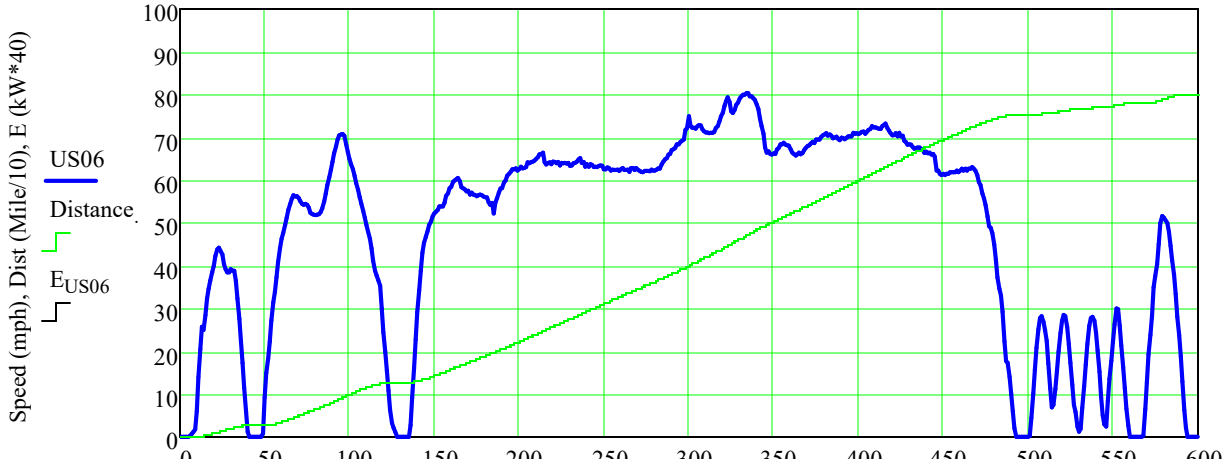

FTP Drive Cycle: Distance, E(Bat Drain)

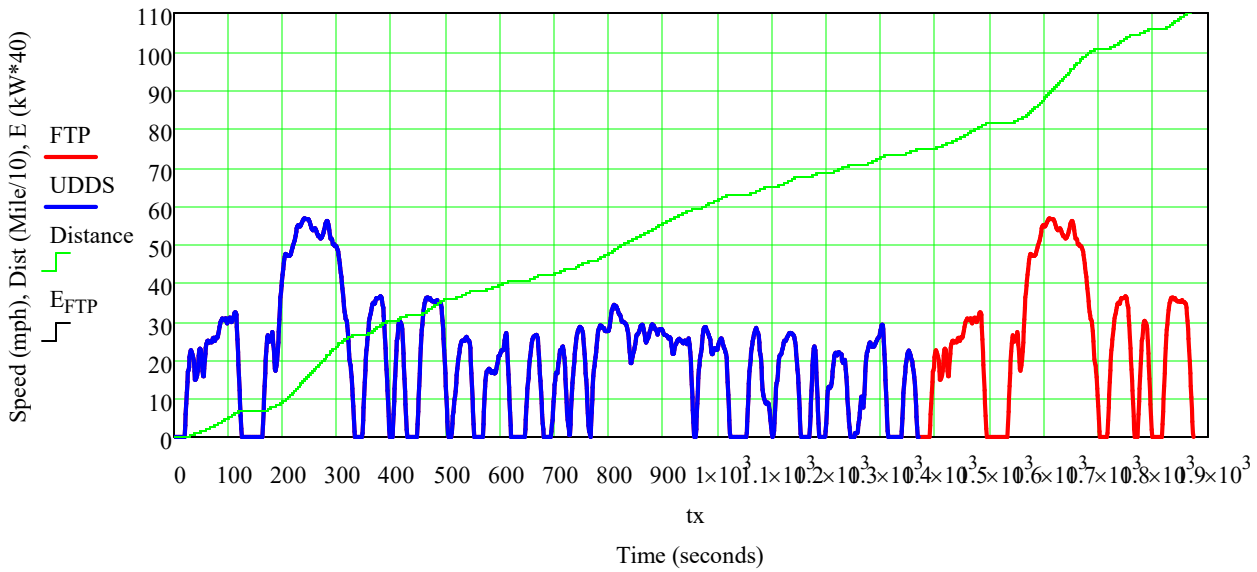

# Compare 2010 Prius (Black) vs. Sustaining Mode Volt (Red) Acceleration Performance

<https://www.vxphysics.com/Transportation/>

Read Charge Depletion Mode Data

Read Charge Sustaining Mode Data (Disabled)

Data Format in File: Time, Vel, Angular Speed, MPH, Accel(g), Torque(rpm), Power (rpm), Force(v), P(v)

Volt := READPRN("C:\Users\tom\Documents\\_Mathcad\Electric\_Vehicles\Transportation\Volt\_tVelwMAGTPmFP.prn")

Volt := READPRN("VoltGenOnly\_tVelwMAGTPmFP.prn")

$$\begin{aligned} & \text{cols}(\text{Volt}) = 10 \quad \text{time}_v := \text{Volt}^{(0)} \\ & n := 0..300 \quad P_{\text{tot}}(v) := F_{\text{tot}}(v \cdot \text{mph}) \cdot v \cdot \text{mph} \cdot \text{hp}^{-1} \\ & \text{PT}(v) := \frac{P_{\text{tot}}(v \cdot \text{mph})}{\text{hp}} \quad v_v := \text{Volt}^{(1)} \quad \omega_v := \text{Volt}^{(2)} \cdot k \quad \text{mph}_v := \text{Volt}^{(3)} \quad g_v := \text{Volt}^{(4)} \quad t_{z_n} := \frac{n}{10} \\ & q := (\text{N} \cdot \text{m})^{-1} \quad T_v := \text{Volt}^{(5)} \quad P_v := \text{Volt}^{(6)} \quad F_v := \text{Volt}^{(7)} \quad P_{v_v} := \text{Volt}^{(8)} \quad P_{\text{cruise}v} := \text{Volt}^{(9)} \\ & \omega_{x_n} := \frac{6000 \cdot n}{200} \quad T_{\text{tot}_n} := T_{\text{tot}}(\omega_{x_n}) \cdot q \quad T_{m2_n} := T_{m2}(\omega_{x_n}) \cdot q \quad T_{\text{ice}_n} := T_{\text{icem}2}(\omega_{x_n}) \cdot q \quad V_{x_n} := \text{velocity}(t_{z_n}) \\ & A_x(V_x) := \frac{(F_{\text{tot}}(V_x \cdot \text{mph}) - F_o(V_x \cdot \text{mph})) \cdot 100}{k_m \cdot M_{\text{gross}} \cdot g} \quad a_{x_n} := A_x(V_{x_n}) \quad F_{t_n} := \frac{F_{\text{tot}}(V_{x_n} \cdot \text{mph})}{N} \quad P_{t_n} := \frac{P_{\text{tot}}(V_{x_n} \cdot \text{mph})}{\text{hp}} \\ & \text{PreWtTotM2ICVA} := \text{augment}(\omega_x, t_z, T_{\text{tot}}, T_{m2}, T_{\text{ice}}, V_x, a_x, F_t, P_t) \quad \text{WRITEPRN}(\text{"Pre3PB0.txt"}) := \text{PreWtTotM2ICVA} \end{aligned}$$

Volt Power reduced from 111 kW to Generator Power x 90% = 47.7 kW in Sustaining Mode.

Volt 0 to 60 mph time increases from 8.5 to 15 seconds.

**Volt 40 mph to 60 mph Sustaining passing time increased from 3.3 seconds to 8.5 seconds.**

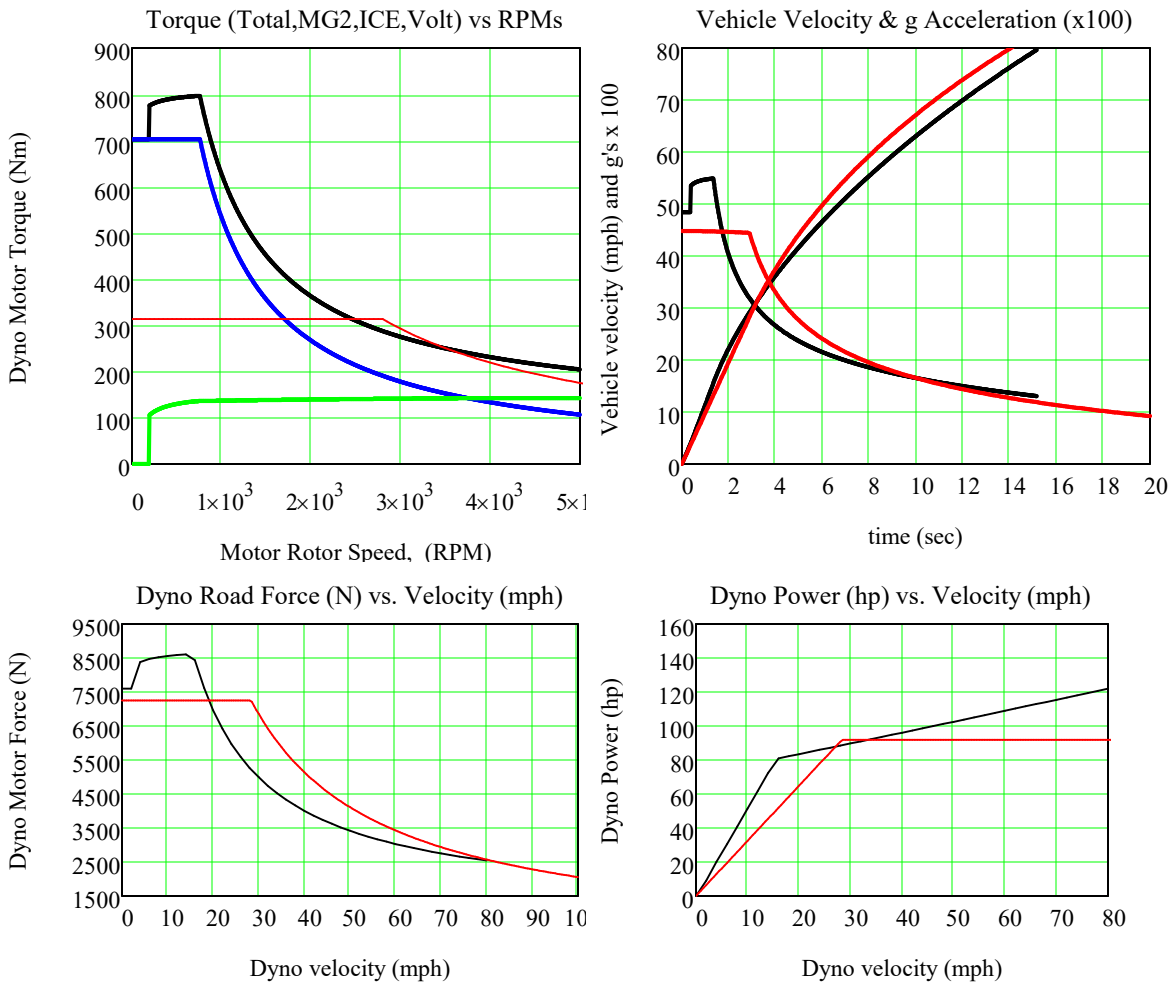

**Read Comparison Files Either for GenIV No Battery Power or Full Power Gen III Prius**

$\omega_z := \text{Pre}^{\langle 0 \rangle}$      $\text{time}_z := \text{Pre}^{\langle 1 \rangle}$      $T_{\text{totz}} := \text{Pre}^{\langle 2 \rangle}$      $T_{m2z} := \text{Pre}^{\langle 3 \rangle}$      $T_{\text{icez}} := \text{Pre}^{\langle 4 \rangle}$      $V_z := \text{Pre}^{\langle 5 \rangle}$      $az := \text{Pre}^{\langle 6 \rangle}$   
 $F_z := \text{Pre}^{\langle 7 \rangle}$      $P_z := \text{Pre}^{\langle 8 \rangle}$      $A_{g_x}(t) := \frac{\text{accel}(t)}{g}$

**Comparison Prius Gen III (Solid) vs. Prius Gen IV (Dotted)**

**Comparison Prius No Battery (Solid) vs. Battery (Dotted)**

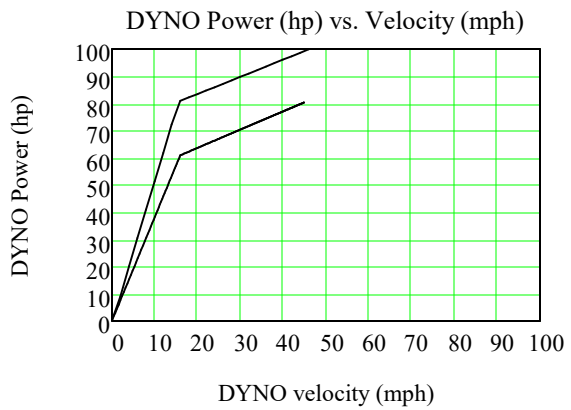
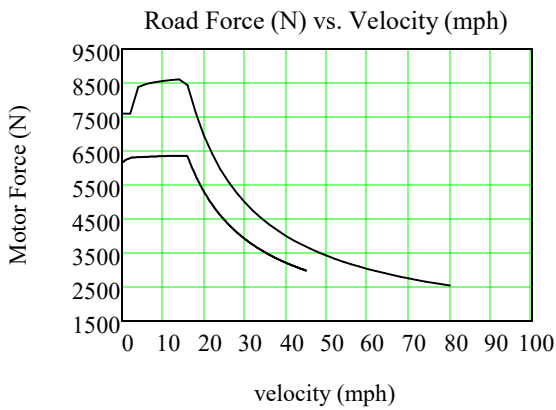
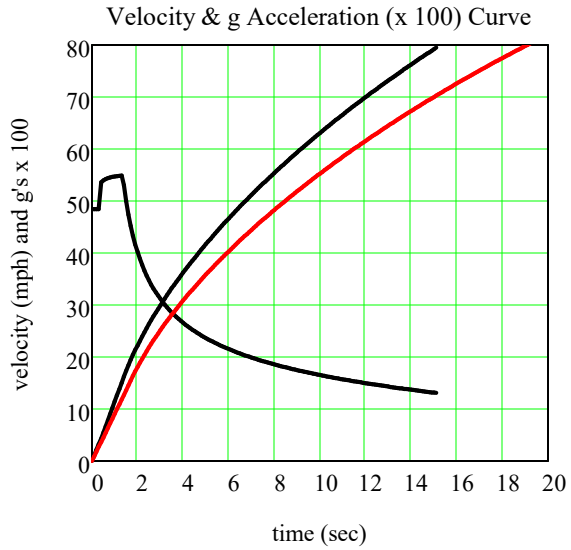
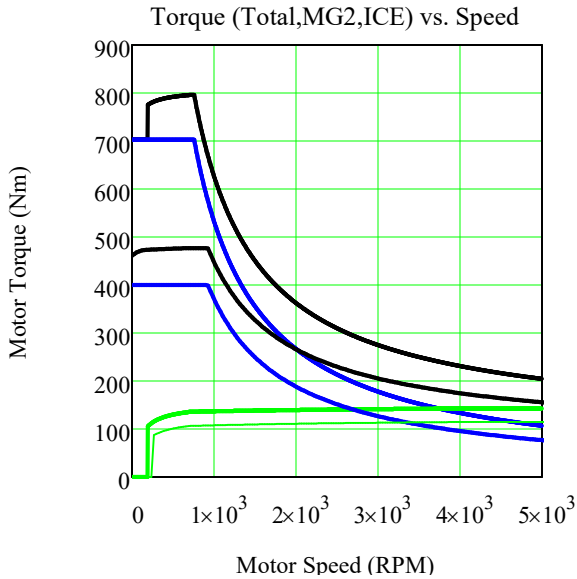

Fuel\_Use := READPRN("Prius 1\_5L Atkinson Fuel Use.TXT")<sup>T</sup>

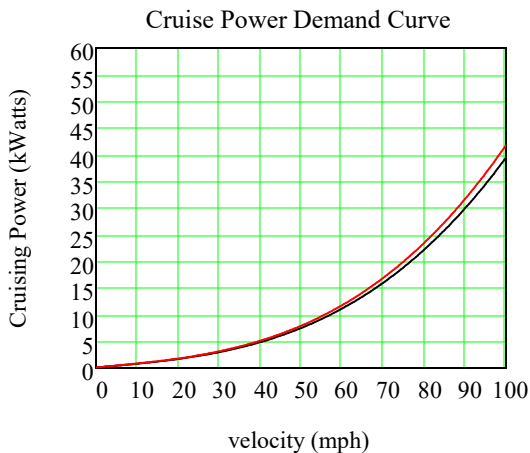

**Switch Solid and Dotted Curves**

**Comparison Prius No Battery (Dotted) vs. Battery (Solid)**

**Comparison Prius Gen III (Dotted) vs. Prius Gen IV (Solid)**

